

COMBIDEX®

Turning Tools



Ordering Code Specifications	page
POSITIVE TURNING INSERTS CA(P)	
• CCGT	4
• DCGT	4
• TCGT	5
• VCGT	5
POSITIVE EXTERNAL TOOLHOLDERS	
• SCLCR/L	8
• SDJCR/L	9
• SDNCN	9
• STFCR/L	10
• STGCR/L	10
• SVJCR/L	11
• SVVCN	11
POSITIVE INTERNAL TOOLHOLDERS	
• S...SCLCR/L	15
• A...SCLCR/L (Internal Coolant)	15
• E...SCLCR/L (Solid Carbide Int. Coolant)	16
• S...SDQCR/L	17
• A...SDQCR/L (Internal Coolant)	17
• E...SDQCR/L (Solid Carbide Int. Coolant)	18
• S...SDUCR/L	19
• A...SDUCR/L (Internal Coolant)	19
• E...SDUCR/L (Solid Carbide Int. Coolant)	20
• S...STFCR/L	21
• E...STFCR/L (Solid Carbide Int. Coolant)	21
• S...SVQCR/L	22
• S...SVUCR/L	22

Ordering Code Specifications	page
NEGATIVE TURNING INSERTS HA(P)	
• CNMG	6
• DNMG	6
• SNMG	6
• TNMG	7
• WNMG	7
NEGATIVE EXTERNAL TOOLHOLDERS	
• PCLNR/L	12
• PDJNR/L	12
• PSSNR/L	13
• PTGNR/L	13
• PWLNR/L	14
NEGATIVE INTERNAL TOOLHOLDERS	
• S...PCLNR/L	23
• S...PDUNR/L	23
• S...PSKNR/L	24
• S...PTFNR/L	24
• S...PWLNR/L	24
Cutting Conditions	25

CCGT
Turning Inserts

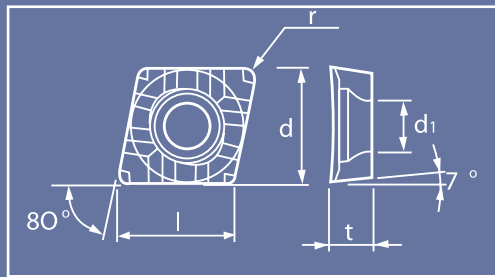

CAP K10 = Polished
CA PA40 = Coated

In Stock = •
On Request = -

l	d	t	r	d1	K10	PA40	•/-	Ordering code
6.5	6.35	2.38	0.2	2.8	CAP	CA	•	CCGT 060202
↓	↓	↓	0.4	↓	CAP	CA	•	CCGT 060204
↓	↓	↓	0.8	↓	CAP	CA	•	CCGT 060208
9.7	9.525	3.97	0.2	4.4	CAP	CA	•	CCGT 09T302
↓	↓	↓	0.4	↓	CAP	CA	•	CCGT 09T304
↓	↓	↓	0.8	↓	CAP	CA	•	CCGT 09T308
12.9	12.7	4.76	0.2	5.5	CAP	CA	•	CCGT 120402
↓	↓	↓	0.4	↓	CAP	CA	•	CCGT 120404
↓	↓	↓	0.8	↓	CAP	CA	•	CCGT 120408

DCGT
Turning Inserts

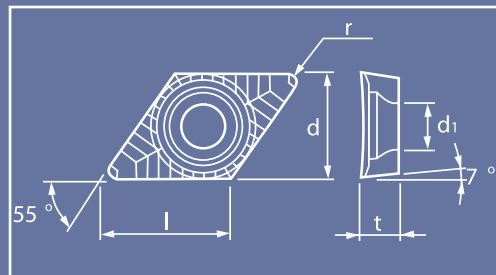

CAP K10 = Polished
CA PA40 = Coated

In Stock = •
On Request = -

l	d	t	r	d1	K10	PA40	•/-	Ordering code
7.8	6.35	2.38	0.2	2.8	CAP	CA	•	DCGT 070202
↓	↓	↓	0.4	↓	CAP	CA	•	DCGT 070204
↓	↓	↓	0.8	↓	CAP	CA	•	DCGT 070208
11.6	9.525	3.97	0.2	4.4	CAP	CA	•	DCGT 11T302
↓	↓	↓	0.4	↓	CAP	CA	•	DCGT 11T304
↓	↓	↓	0.8	↓	CAP	CA	•	DCGT 11T308
↓	↓	↓	1.2	↓	CAP	CA	•	DCGT 11T312

TCGT
Turning Inserts

CAP K10 = Polished
CA PA40 = Coated

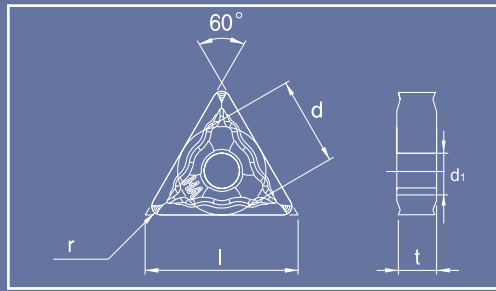

In Stock = •
On Request = -

Ordering code	•/-	K10	PA40	l	d	t	r	d1
TCGT 110202	•	CAP	CA	11.0	6.35	2.38	0.2	2.8
TCGT 110204	•	CAP	CA	↓	↓	↓	0.4	↓
TCGT 110208	•	CAP	CA	↓	↓	↓	0.8	↓
TCGT 16T302	•	CAP	CA	16.5	9.525	3.97	0.2	4.4
TCGT 16T304	•	CAP	CA	↓	↓	↓	0.4	↓
TCGT 16T308	•	CAP	CA	↓	↓	↓	0.8	↓
TCGT 16T312	-	CAP	CA	↓	↓	↓	1.2	↓
TCGT 16T316	-	CAP	CA	↓	↓	↓	1.6	↓

VCGT
Turning Inserts

CAP K10 = Polished
CA PA40 = Coated

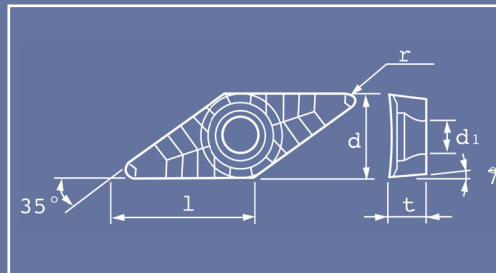

In Stock = •
On Request = -

Ordering code	•/-	K10	PA40	l	d	t	r	d1
VCGT 110302	•	CAP	CA	11.0	6.35	3.18	0.2	2.8
VCGT 110304	•	CAP	CA	↓	↓	↓	0.4	↓
VCGT 110308	•	CAP	CA	↓	↓	↓	0.8	↓
VCGT 130302	•	CAP	CA	13.8	7.94	3.18	0.2	3.4
VCGT 130304	•	CAP	CA	↓	↓	↓	0.4	↓
VCGT 160402	•	CAP	CA	16.5	9.525	4.76	0.2	4.4
VCGT 160404	•	CAP	CA	↓	↓	↓	0.4	↓
VCGT 160408	•	CAP	CA	↓	↓	↓	0.8	↓
VCGT 160412	•	CAP	CA	↓	↓	↓	1.2	↓
VCGT 220525	-	CAP	CA	22.1	12.7	5.56	2.5	5.6
VCGT 220530	-	CAP	CA	↓	↓	↓	3.0	↓

CNMG
Turning Inserts

HAP K10 = Polished

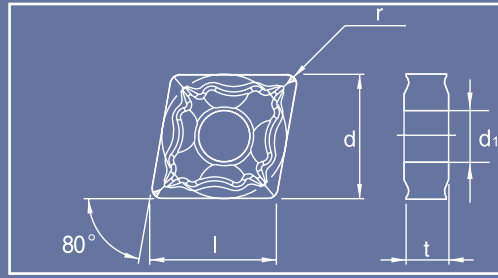

In Stock = •
On Request = -

l	d	t	r	d1	K10	•/-	Ordering code
12.9	12.7	4.76	0.4	5.16	HAP	•	CNMG 120404
↓	↓	↓	0.8	↓	HAP	•	CNMG 120408
↓	↓	↓	1.2	↓	HAP	•	CNMG 120412

DNMG
Turning Inserts

HAP K10 = Polished

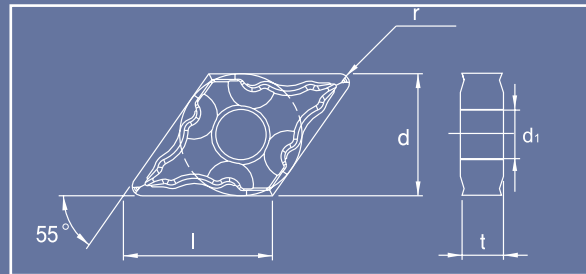

In Stock = •
On Request = -

l	d	t	r	d1	K10	•/-	Ordering code
15,5	12.7	6.35	0.4	5.16	HAP	•	DNMG 150604
↓	↓	↓	0,8	↓	HAP	•	DNMG 150608

SNMG
Turning Inserts

HAP K10 = Polished

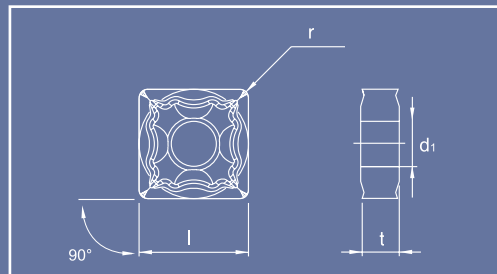

In Stock = •
On Request = -

l	d	t	r	d1	K10	•/-	Ordering code
12.7	12.7	4.76	0.4	5.16	HAP	•	SNMG 120404
↓	↓	↓	0.8	↓	HAP	•	SNMG 120408
↓	↓	↓	1.2	↓	HAP	•	SNMG 120412

HAP K10 = Polished

TNMG
Turning Inserts

Insert

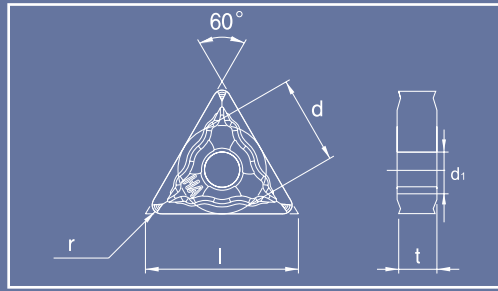
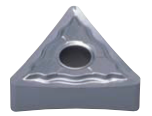

In Stock = •
On Request = -

Ordering code	•/-	K10	l	d	t	r	d1
TNMG 160404	•	HAP	16.5	9.525	4.76	0.4	3.8
TNMG 160408	•	HAP				0.8	

HAP K10 = Polished

WNMG
Turning Inserts

Insert

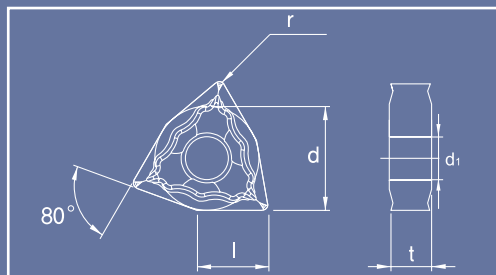
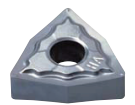

In Stock = •
On Request = -

Ordering code	•/-	K10	l	d	t	r	d1
WNMG 060404	•	HAP	6.52	9.525	4.76	0.4	3.81
WNMG 060408	•	HAP				0.8	
WNMG 080404	•	HAP	8.7	12.7	4.76	0.4	5.16
WNMG 080408	•	HAP	↓	↓	↓	0.8	↓
WNMG 080412	•	HAP				1.2	↓

SCLCR/L
External Toolholder

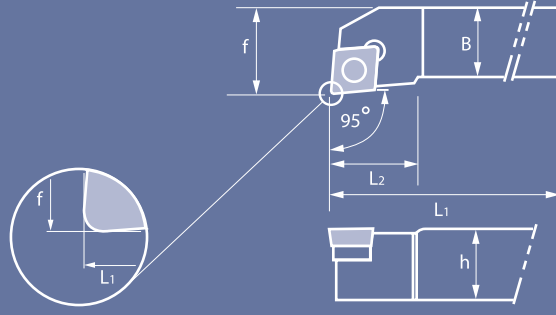
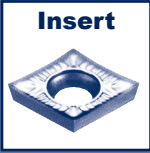

h	b	L1	L2	f	Insert	Ordering Code
8	8	60	10	10	CCGT 0602...	FTKA 02565 CT 07 SCLCR/L 0808.D06
10	10	70	10	12		SCLCR/L 1010.E06
12	12	80	15	16	CCGT 09T3...	FTGA 03508 CT 15 SCLCR/L 1212.F09
16	16	100	15	20		SCLCR/L 1616.H09
20	20	125	17	25		SCLCR/L 2020.K09
20	20	125	20	25	CCGT 12... SC 42 S SHXN 0610 F FTGA 0411 F	CT 15 SCLCR/L 2020.K12
25	25	150	21	32		SCLCR/L 2525.M12

SCLCR/L
External Toolholder

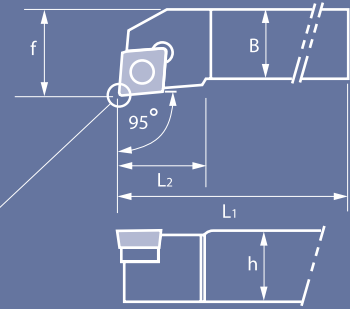

Ordering code



Insert

h

b

L1

L2

f

SDJCR/L 0808.D07			FTKA 02565	CT 07	DCGT 0702...	8	8	60	14	10
SDJCR/L 1010.E07			↓	↓		10	10	70	14	12
SDJCR/L 1212.E07			↓	↓		12	12	80	14	16
SDJCR/L 1212.F11			FTGA 03512	CT 15	DCGT 11T3...	12	12	80	21	16
SDJCR/L 1616.H11			↓	↓		16	16	100	21	20
SDJCR/L 2020.K11	SD 32 S	SHXN 0509 F	FTGA 03512	CT 15	DCGT 11T3...	20	20	125	22	25
SDJCR/L 2525.M11	↓	↓	↓	↓		25	25	150	24	32

SCLCR/L
External Toolholder

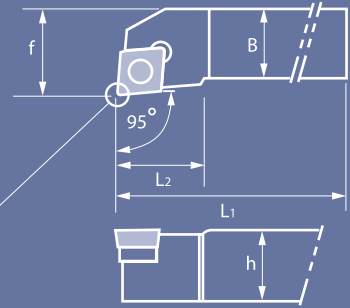

Ordering code



Insert

h

b

L1

L2

f

SDNCN 0808.D07			FTKA 02565	CT 07	DCGT 0702...	8	8	60	9	4,0
SDNCN 1010.E07			↓	↓		10	10	70	11	5,0
SDNCN 1212.F07			↓	↓		12	12	80	13	6,0
SDNCN 1212.F11			FTGA 03512	CT 15	DCGT 11T3...	12	12	80	12	6,0
SDNCN 1616.H11			↓	↓		16	16	100	16	8,0
SDNCN 2020.K11	SD 32 S	SHXN 0509 F	FTGA 03512	CT 15	DCGT 11T3...	20	20	125	20	10,0
SDNCN 2525.M11	↓	↓	↓	↓		25	25	150	25	12,5

STFCR/L
External Toolholder

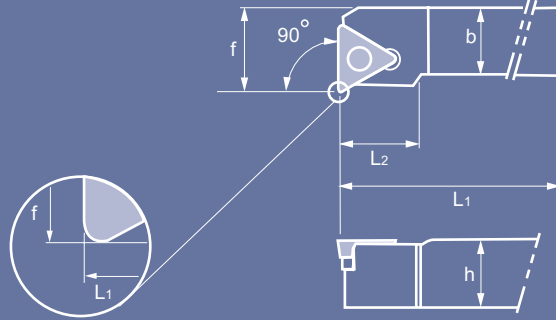

h	b	L ₁	L ₂	f	Insert					Ordering Code
12	12	80	18	16	TCGT 1102...			FTKA 02565	CT 07	STFCR/L 1212.F11
16	16	100	22	20						STFCR/L 1616.H11
20	20	125	22	25	TCGT 16T3...	ST 32 S	SHXN 0509 F	FTGA 03512	CT 15	STFCR/L 2020.K16
25	25	150	22	32						STFCR/L 2525.M16

STGCR/L
External Toolholder

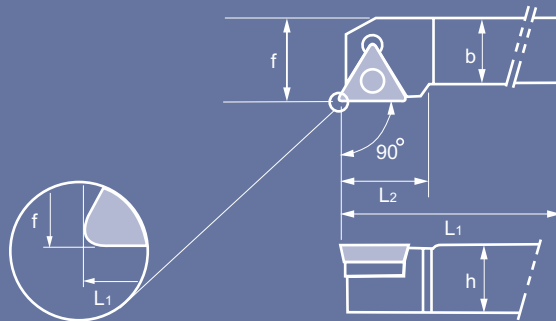

h	b	L ₁	L ₂	f	Insert					Ordering Code
12	12	80	18	16	TCGT 1102...			FTKA 02565	CT 07	STGCR/L 1212.F11
16	16	100	22	20				↓	↓	STGCR/L 1616.H11
20	20	125	22	25	TCGT 16T3...	ST 32 S	SHXN 0509F	FTGA 03512	CT 15	STGCR/L2020.K16
25	25	150	22	32				↓	↓	STGCR/L.2525.M16

SVJCR/L
External Toolholder

Insert

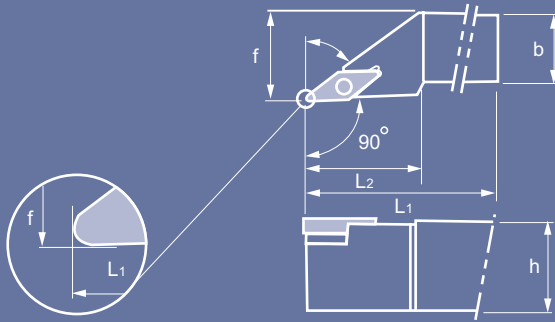

Ordering code					Insert	h	b	L1	L2	f
SVJCR/L 1212.F11			FTKA 02565	CT 07	VCGT 1103...	12	12	80	24	16
SVJCR/L 1616.H11						16	16	100	24	20
SVJCR/L 2020.K11						20	20	125	24	25
SVJCR/L 2525.M11						25	25	150	27	32
SVJCR/L 2020.K16	SV 32 S	SHXN 0509 F	FTGA 03512	CT 15	VCGT 1604...	20	20	125	30	25
SVJCR/L 2525.M16						25	25	150	33	32
SVJCR/L 3225.P16						32	25	170	41	32

SVVCN
External Toolholder



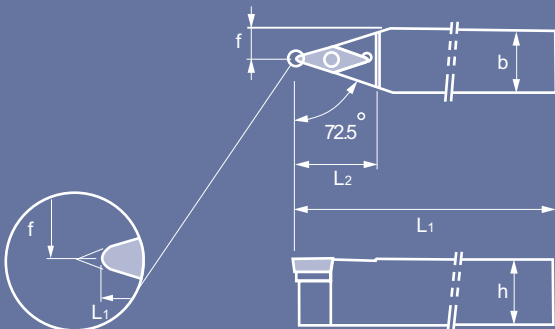

Insert

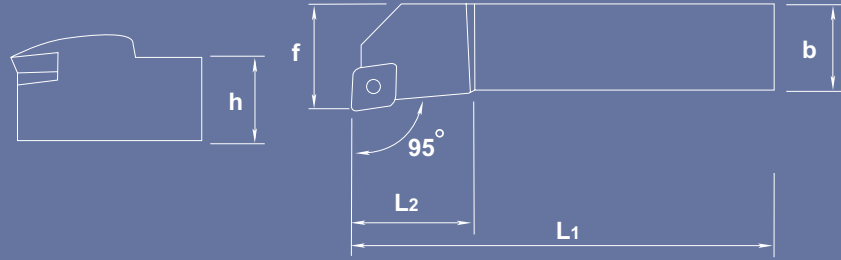

Ordering code					Insert	h	b	L1	L2	f
SVVCN 1212.F11			FTKA 02565	CT 07	VCGT 1103...	12	12	80	26	8
SVVCN 1616.H11						16	16	100	26	8
SVVCN 2020.K11						20	20	125	32	10
SVVCN 2525.M11						25	25	150	40	12,5
SVVCN 2020.K16	SV 32 S	SHXN 0509 F	FTGA 03512	CT 15	VCGT 1604...	20	20	125	34	10
SVVCN 2525.M16						25	25	150	42	12,5
SVVCN 3225.P16						32	25	170	42	12,5





PCLNR/L
External Toolholder

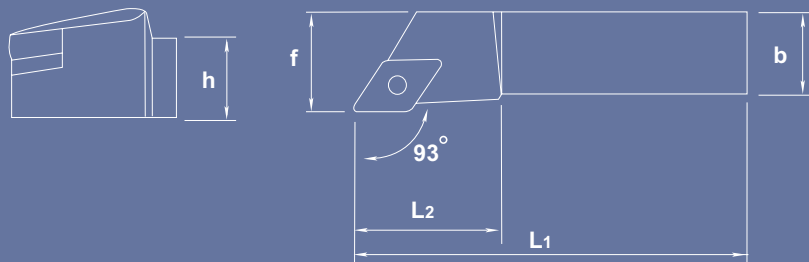

h	b	L ₁	L ₂	f	Insert					Ordering Code
16	16	100	26	20	CNMM/G 1204..					PCLN R/L 1616 H12
20	20	125	28	25						PCLN R/L 2020 K12
25	25	150	28	32						PCLN R/L 2525 M12
32	25	170	28	32						PCLN R/L 3225 P12
32	32	170	28	40						PCLN R/L 3232 P12
25	25	150	34	32	CNMM/G 1606..					PCLN R/L 2525 M16
32	25	170	34	32						PCLN R/L 3225 P16
32	32	170	34	40						PCLN R/L 3232 P16
40	40	250	34	50						PCLN R/L 4040 S16
25	25	150	42	32	CNMM/G 1906..					PCLN R/L 2525 M19
32	25	170	42	32						PCLN R/L 3225 P19
32	32	170	42	40						PCLN R/L 3232 P19
40	40	250	43	50						PCLN R/L 4040 S19
40	40	250	45	50	CNMM/G 2507..					PCLN R/L 4040 S25
50	50	300	45	60						PCLN R/L 5050 T25

PDJNR/L
External Toolholder



h	b	L ₁	L ₂	f	Insert					Ordering Code
16	16	100	28	20	DNMM/G 1104..					
20	20	125	28	25						
25	25	150	28	32						
32	25	170	28	32						
20	20	125	34	25	DNMM/G 1506..					
25	25	150	34	32						
32	25	170	34	32						
32	32	170	34	40						
40	25	200	34	32						
50	32	250	34	40						

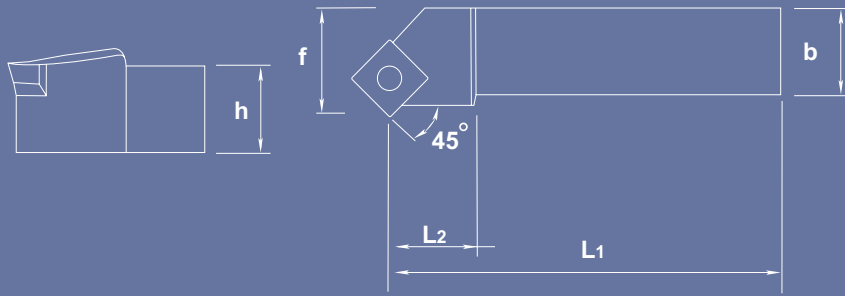

PSSNR/L
External Toolholder



Ordering code					Insert	h	b	L ₁	L ₂	f
PSSN R/L 2020 K12					SNMM/G 1204..	20	20	125	28	25
PSSN R/L 2525 M12						25	25	150	28	32
PSSN R/L 3225 P12						32	25	170	28	32
PSSN R/L 2525 M15					SNMM/G 1506..	25	25	150	34	32
PSSN R/L 3232 P15						32	32	170	34	40
PSSN R/L 3232 P19					SNMM/G 1906..	32	32	170	42	40
PSSN R/L 4040 S19						40	40	250	45	50
PSSN R/L 5050 T19						50	50	300	45	60
PSSN R/L 4040 S25					SNMM/G 2507..	40	40	250	45	50
PSSN R/L 5050 T25						50	50	300	45	60

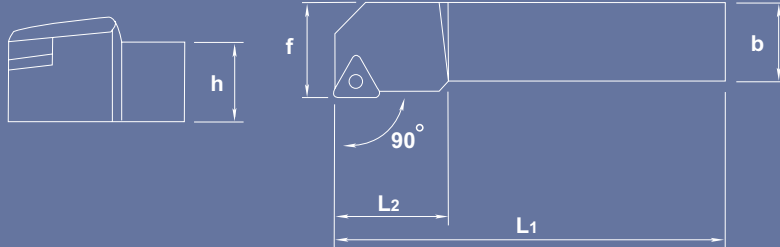

PTGNR/L
External Toolholder



Ordering code					Insert	h	b	L ₁	L ₂	f
PTGN R/L 1616 H16					TNMM/G 1604..	100	22	20	16	16
PTGN R/L 2020 K16						125	22	25	20	20
PTGN R/L 2525 M16						150	22	32	25	25
PTGN R/L 3225 P16						170	22	32	32	25
PTGN R/L 2525 M22					TNMM/G 2204..	150	28	32	25	25
PTGN R/L 3225 P22						170	28	32	32	25
PTGN R/L 3232 P22						170	28	40	32	32
PTGN R/L 4040 S22						250	34	50	40	40
PTGN R/L 3232 P27					TNMM/G 2706..	170	42	40	32	32
PTGN R/L 4040 S27						250	45	50	40	40

PWLNR/L
External Toolholder

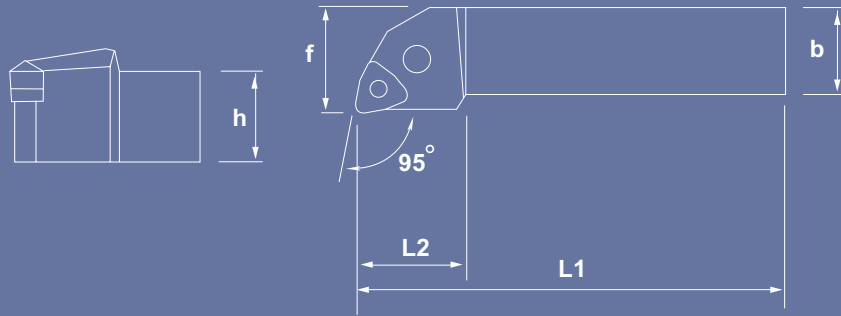
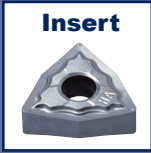

h	b	L1	L2	f	Insert	Ordering Code
16	16	100	15	20		WNMM/G 0604..
20	20	125	25	25		
25	25	150	25	32		
20	20	125	34	25		WNMM/G 0804..
25	25	150	34	32		
32	25	170	34	32		
32	32	170	34	40		

S...SCLCR/L
Internal Toolholder

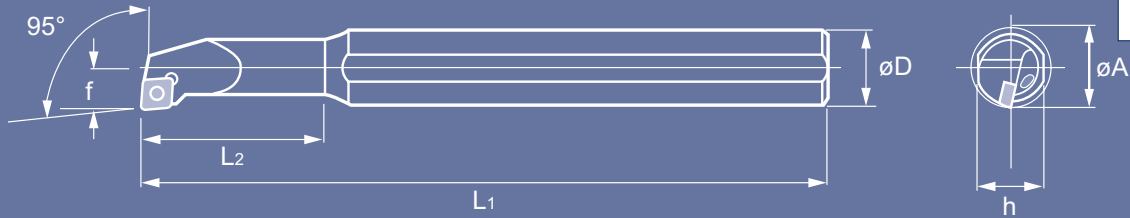

Ordering Code	Insert					L1	L2	f	h	øD	øA
S08K SCLC R/L 06	CC..T 0602..	-	-	FTGA 02565	CT08	125	16	5	7	8	11
S10M SCLC R/L 06						150	25	7	9	10	13
S12M SCLC R/L 06						150	25	9	11	12	16
S12M SCLC R/L 09	CC..T 09T3...	-	-	FTGA 03508	CT 15	180	25	9	11	12	16
S16R SCLC R/L.09						200	30	11	15	16	20
S20S SCLC R/L.09						250	35	13	18	20	24
S25T SCLC R/L.12	CC..T 1204...	SC 42 S	SHXN 0610 F-	FTGA 0411 F	CT20	300	40	17	23	25	31
S32U SCLC R/L.12						350	50	22	30	32	39
S40V SCLC R/L.12						400	60	27	37	40	48
S50W SCLC R/L.12						450	65	35	47	50	61



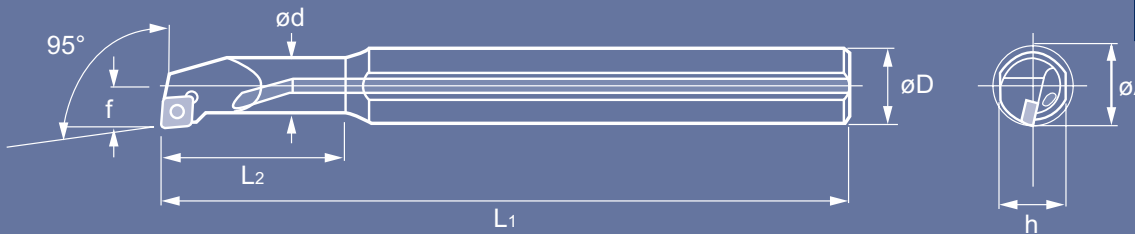

A...SCLCR/L
Internal Toolholder

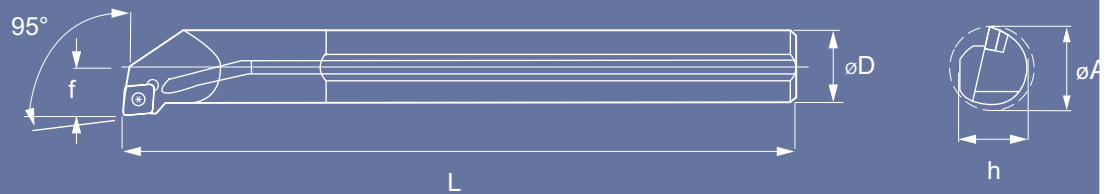

Ordering Code	Insert					L1	L2	f	h	øD	ød	øA
A0608H-SCLCR/L.06	CC..T 0602...	-	-	VI25	CT 08	100	26	4	7	8	6	8,5
A0810H-SCLCR/L.06						100	32	6	9	10	8	12
A1012K-SCLCR/L.06						125	40	7	11	12	10	14
A1216M-SCLCR/L.06						150	52	9	15	16	12	18

E...SCLCR/L
Internal Toolholder



L	f	h	øD	øA	Insert					Ordering Code
125	5	7,5	8	10	CC..T 0602...			VT2506	CT 08	E08K-SCLCR/L.06
150	6	9,5	10	12						E10M-SCLCR/L.06
180	9	11,5	12	16						E12Q-SCLCR/L.06
180	9	11,5	12	16	CC..T 09T3...			VT3508	CT 15	E12Q-SCLCR/L.09
200	11	15,5	16	20						E16R-SCLCR/L.09
250	13	19	20	25						E20S-SCLCR/L.09
300	17	24	25	32	CC..T 1204...			VT3512	CT15	E25T-SCLCR/L.12

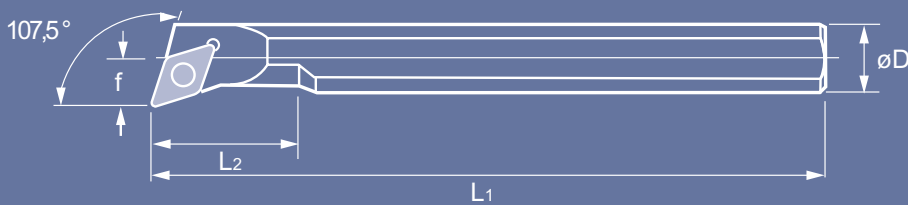

S...SDQCR/L
Internal Toolholder



Ordering Code	Insert					L ₁	L ₂	f	h	øD	øA
S10MSDQCR/L.07	DC..T 0702..	-	-	FTKA 02565	CT 07	150	25	7	9	10	13
S12MSDQCR/L.07						150	25	9	11	12	16
S16RSDQCR/L.07						200	30	11	15	16	20
S20S SDQCR/L.07						250	35	13	18	20	24
S25T SDQCR/L.11	DC..T 11T3..	-	-	FTGA 03510	CT 15	300	40	17	23	25	31
S32U SDQCR/L.11		SD32S	SHXN 0509 F	FTGA 03512		350	50	22	30	32	39
S40V SDQCR/L.11						400	60	27	37	40	48

With internal coolant

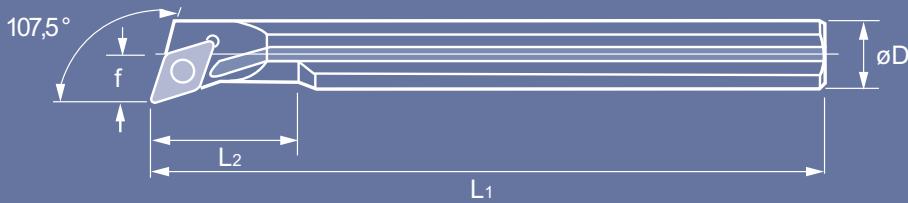





A...SDQCR/L
Internal Toolholder

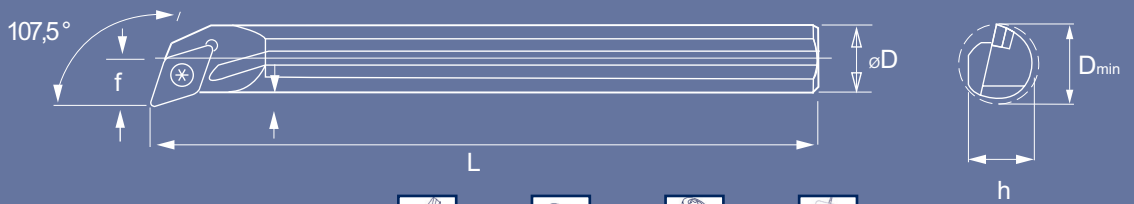

Ordering Code	Insert					L ₁	L ₂	f	h	øD	øA
A0810H SDQCR/L.07	DC..T 0702..	-	-	VT 25	CT 08	100	22	7	9	10	12,5
A1012K SDQCR/L.07						125	28	9	11	12	15,5
A1216M SDQCR/L.07						150	36	11	15	16	19,5

E...SDQCR/L
Internal Toolholder



L	f	h	øD	øA	Insert					Ordering Code
125	6	7,5	8	12	DC..T 0702..			VT 2506	CT 08	E 08 K-SDQCR/L.07
150	7	9,5	10	13						E 10 M-SDQCR/L.07
180	9	11,5	12	16						E 12 Q-SDQCR/L.07
200	11	15,5	16	20						E 16 R-SDQCR/L.07
200	11	15,5	16	20	DC..T 11T3..			VT 3508	CT15	E 16 R-SDQCR/L.11
250	13	19	20	25						E 20 S-SDQCR/L.11
300	17	24	25	32						

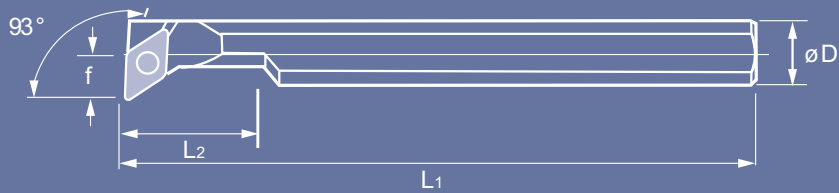

S...SDUCR/L
Internal Toolholder



Ordering code	Insert					L1	L2	f	h	ØD	ØA
S10M SDUCR/L 07	DC..T 0702..	-	-	-	-	150	25	7	9	10	13
S12M SDUCR/L 07						150	25	9	11	1	16
S16R SDUCR/L 07				FTKA 02565	CT 07	200	30	11	15	16	20
S20S SDUCR/L.11	DC..T 11T3..			FTGA 04020	CT 15	250	35	13	18	20	24
S25T SDUCR/L.11						300	40	17	23	25	31.
S32U SDUCR/L.11		SD32S	SHXN 0509	FTGA 03512	CT 20	350	50	22	30	32	39
S40V SDUCR/L.11						400	60	27	37	40	48

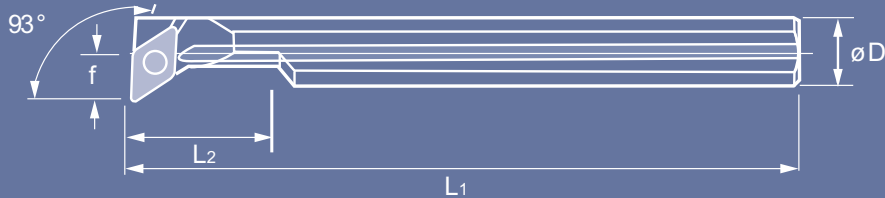





A...SDUCR/L
Internal Toolholder



Ordering code	Insert					L1	L2	f	h	ØD	ØA
A0810H SDUCR/L.07	DC..T 0702..	-	-	VT 25	CT 08	100	22	7	9	10	12,5
A1012K SDUCR/L.07						125	28	9	11	12	15,5
A1216M SDUCR/L.07						150	36	11	15	16	19,5

E...SDUCR/L
Internal Toolholder



L	f	h	øD	øA	Insert					Ordering Code
125	6	7,5	8	12	DC..T 0702	-	-	VT2506	CT08	E08K-SDUCR/L.07
150	7	9,5	10	13						E10M-SDUCR/L.07
180	9	11,5	12	16						E12Q-SDUCR/L.07
200	11	15,5	16	20						E16R-SDUCR/L.07
200	11	15,5	16	20	DC..T 11T3	-	-	VT3508	CT15	E16R-SDUCR/L.11
250	13	19	20	25						E20S-SDUCR/L.11
300	17	24	25	32						E25T-SDUCR/L.11

S...STFCR/L
Internal Toolholder

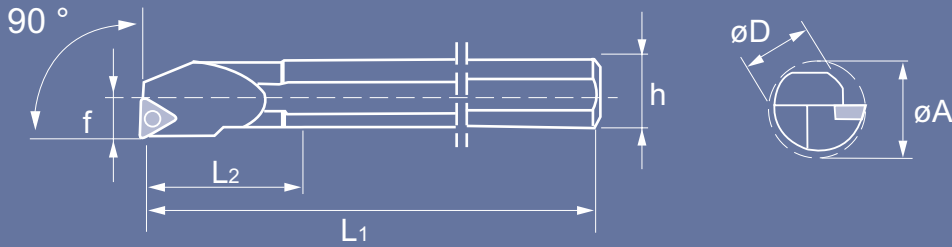

Ordering code	Insert					L ₁	L ₂	f	h	ø D	ø A
S12M-STFCR/L.11	TC..T 1102	-	-	FTKA 02565	CT07	150	25	9	11	12	16
S16R-STFCR/L.16	TC..T 16T3	-	-	FTKGA 03512	CT15	200	30	11	15	16	20
S20S-STFCR/L.16						250	35	13	18	20	24
S25T-STFCR/L.16						300	40	17	23	25	31
S32U-STFCR/L.16						350	50	22	30	32	39

E...STFCR/L
Internal Toolholder



Ordering code	Insert					L ₁	f	h	ø D	ø A
E10M-STFCR/L.09	TC..T 0902..	-	-	VT2245	CT06	150	7	9.5	10	13
E12Q-STFCR/L.11	TC..T 1102..	-	-	VT2506	CT08	180	8	11.5	12	16
E16R-STFCR/L.16	TC..T 16T3..	-	-	VT3508	CT15	200	10	15.5	16	20
E20S-STFCR/L.16						250	12	19	20	24

A...SVQCR/L
Internal Toolholder

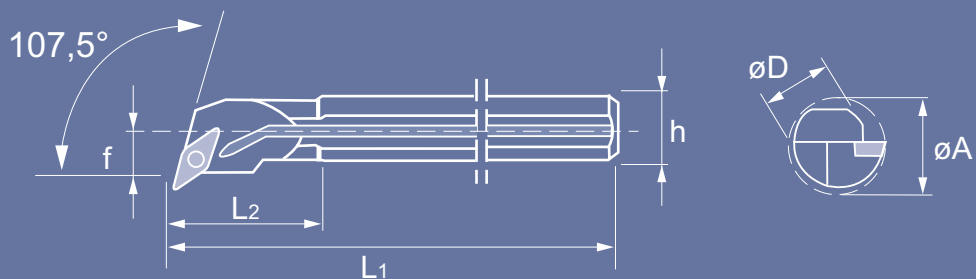

L1	L2	f	h	ø D	ø A	Insert					Ordering Code
150	-	11	15,25	16	20	VCGT 1103...		FTKA 02565		CT07	A16M SVQCR/L.11
180	-	13	19,00	20	25						A20Q SVQCR/L.11
200	-	17	24,00	25	32	VCGT 1604...		FTGA 03512		CT15	A25R SVQCR/L.16
250	-	22	31,00	32	40						A32S SVQCR/L.16

A...SVUCR/L
Internal Toolholder

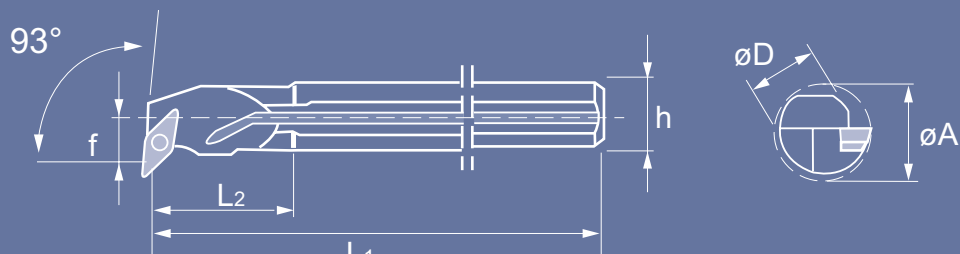

L1	L2	f	h	ø D	ø A	Insert					Ordering Code
150	-	12	15,25	16	21	VCGT 1103...		FTKA 02565		CT07	A16M SVUCR/L.11
180	-	13	19,00	20	25						A20Q SVUCR/L.11
200	-	17	24,00	25	32						A25R SVUCR/L.11
250	-	22	31,00	32	40	VCGT 1604...	SV32S	SHXN 0509 F	FTGA 03512	CT15	A32S SVUCR/L.16

S...PCLNR/L
Internal Toolholder

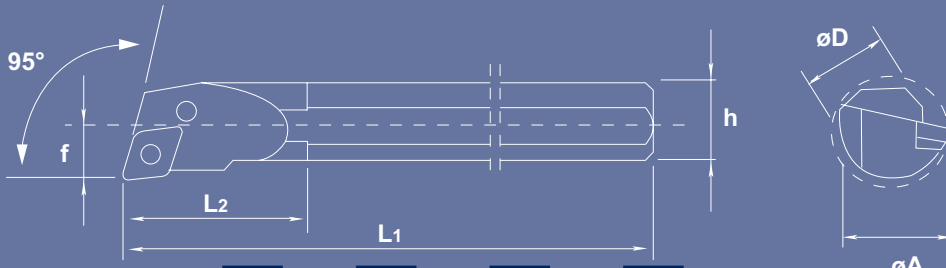

Ordering code



Insert

L₁

L₂

f

h

ø D

ø A

S25T PCLN R/L 12

CNMM/G 1204..

300

40

17

23

25

31

S32U PCLN R/L 12

350

50

22

30

32

39

S40V PCLN R/L 12

400

60

27

37

40

48

S50W PCLN R/L 12

450

65

35

47

50

61

S50W PCLN R/L 16

CNMM/G 1606..

450

65

35

47

50

61

S50W PCLN R/L 19

CNMM/G 1906..

450

65

35

47

50

61

S...PDUNR/L
Internal Toolholder

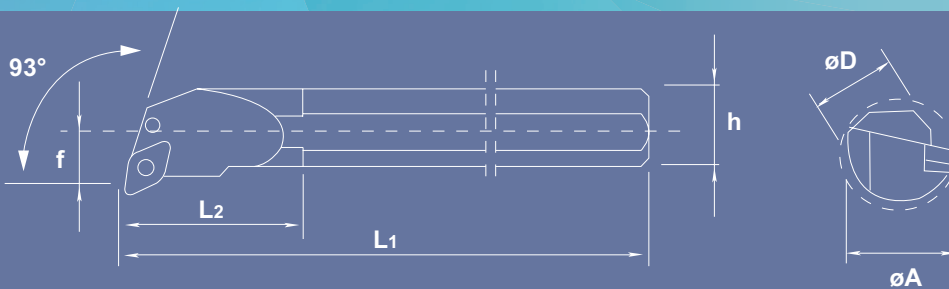

Ordering code



Insert

L₁

L₂

f

h

ø D

ø A

S25T PDUN R/L 11

DNMM/G 1104..

300

35

17

23

25

32

S32U PDUN R/L 15

DNMM/G 1506..

350

50

22

30

32

39

S40V PDUN R/L 15

400

60

27

37

40

48

S50W PDUN R/L 15

450

65

35

47

50

61

S...PTFNR/L
Internal Toolholder

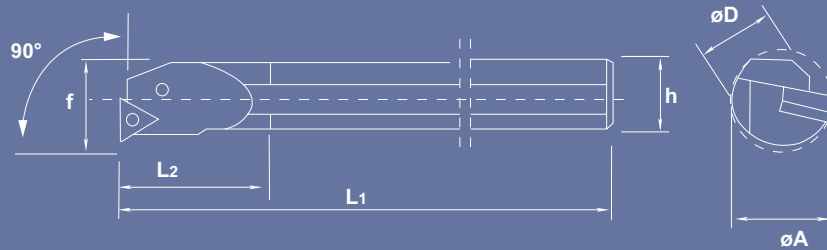

L1	L2	f	h	ø D	ø A	Insert					Ordering Code
300	40	17	23	25	31	TNMM/G 1604..	-	-	-	-	S25T PTFN R/L 16
350	50	22	30	32	39						S32U PTFN R/L 16
400	60	27	37	40	48	TNMM/G 2204..					S40V PTFN R/L 22
450	65	35	47	50	61						S50W PTFN R/L 22

S...PSKNR/L
Internal Toolholder

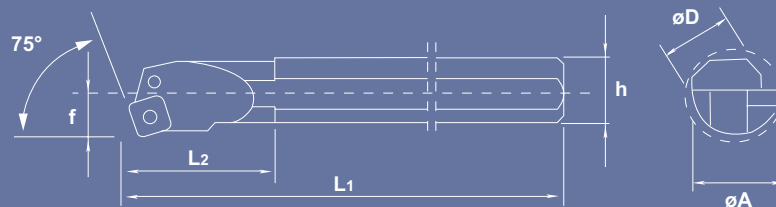

L1	L2	f	h	ø D	ø A	Insert					Ordering Code
300	40	17	23	25	31	SNMM/G 1204..	-	-	-	-	S25T PSKN R/L 12
350	50	22	30	32	39						S32U PSKN R/L 12
400	60	27	37	40	48						S40V PSKN R/L 12
450	65	35	47	50	61	SNMM/G 1906..					S50W PSKN R/L 19

S...PWLNR/L
Internal Toolholder

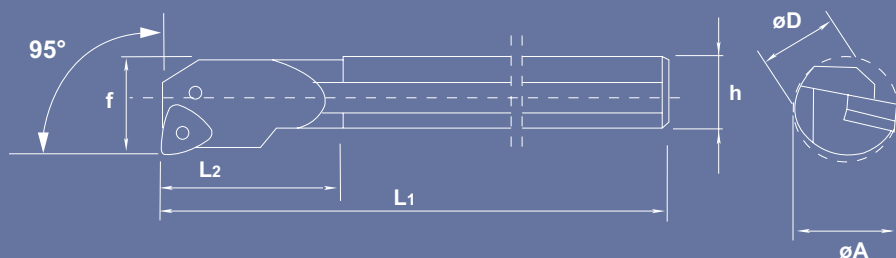

L1	L2	f	h	ø D	ø A	Insert					Ordering Code
200	24	11	14	16	20	WNMM/G 0604..	-	-	-	-	S16R PWLN R/L 06
250	36	13	18	20	27						S20S PWLN R/L 06
300	40	17	23	25	31						S25T PWLN R/L 06
300	40	17	23	25	31	WNMM/G 0804..					S25T PWLN R/L 08
350	50	22	30	32	39						S32U PWLN R/L 08
400	60	27	37	40	48						S40V PWLN R/L 08

Recommended cutting conditions*

ISO insert number	Quality		Feed (mm/rev)		Cutting Speed (mtr/min)		Depth of cut (mm)
	K10	PA40	K10	PA40	K10	PA40	
CCGT 060202	CAP	CA	0.05 ~ 0.15	0.05 ~ 0.10	200 ~ 2500	80 ~ 120	0.3 ~ 2.0
CCGT 060204	CAP	CA	0.10 ~ 0.30	0.10 ~ 0.20	200 ~ 2500	80 ~ 120	0.5 ~ 2.0
CCGT 060208	CAP	CA	0.15 ~ 0.50	0.15 ~ 0.30	200 ~ 2500	80 ~ 120	0.5 ~ 3.5
CCGT 09T302	CAP	CA	0.05 ~ 0.15	0.05 ~ 0.10	200 ~ 2500	80 ~ 120	0.3 ~ 3.5
CCGT 09T304	CAP	CA	0.10 ~ 0.30	0.10 ~ 0.20	200 ~ 2500	80 ~ 120	0.5 ~ 3.5
CCGT 09T308	CAP	CA	0.15 ~ 0.50	0.15 ~ 0.30	200 ~ 2500	80 ~ 120	0.5 ~ 3.5
CCGT 120402	CAP	CA	0.05 ~ 0.15	0.05 ~ 0.10	200 ~ 2500	80 ~ 120	0.3 ~ 5.0
CCGT 120404	CAP	CA	0.10 ~ 0.30	0.10 ~ 0.20	200 ~ 2500	80 ~ 120	0.5 ~ 5.0
CCGT 120408	CAP	CA	0.15 ~ 0.50	0.15 ~ 0.30	200 ~ 2500	80 ~ 120	0.5 ~ 5.0
DCGT 070202	CAP	CA	0.05 ~ 0.15	0.05 ~ 0.10	200 ~ 2500	80 ~ 120	0.3 ~ 2.0
DCGT 070204	CAP	CA	0.10 ~ 0.30	0.10 ~ 0.20	200 ~ 2500	80 ~ 120	0.5 ~ 2.0
DCGT 070208	CAP	CA	0.15 ~ 0.50	0.15 ~ 0.30	200 ~ 2500	80 ~ 120	0.5 ~ 3.5
DCGT 11T302	CAP	CA	0.05 ~ 0.15	0.05 ~ 0.10	200 ~ 2500	80 ~ 120	0.3 ~ 3.5
DCGT 11T304	CAP	CA	0.10 ~ 0.30	0.10 ~ 0.20	200 ~ 2500	80 ~ 120	0.5 ~ 3.5
DCGT 11T308	CAP	CA	0.15 ~ 0.50	0.15 ~ 0.30	200 ~ 2500	80 ~ 120	0.5 ~ 3.5
DCGT 11T312	CAP	CA	0.20 ~ 0.80	0.20 ~ 0.40	200 ~ 2500	80 ~ 120	0.8 ~ 3.5
TCGT 110202	CAP	CA	0.05 ~ 0.15	0.05 ~ 0.10	200 ~ 2500	80 ~ 120	0.3 ~ 3.5
TCGT 110204	CAP	CA	0.10 ~ 0.30	0.10 ~ 0.20	200 ~ 2500	80 ~ 120	0.5 ~ 3.5
TCGT 110208	CAP	CA	0.15 ~ 0.50	0.15 ~ 0.30	200 ~ 2500	80 ~ 120	0.5 ~ 3.5
TCGT 16T302	CAP	CA	0.05 ~ 0.15	0.05 ~ 0.10	200 ~ 2500	80 ~ 120	0.3 ~ 3.5
TCGT 16T304	CAP	CA	0.10 ~ 0.30	0.10 ~ 0.20	200 ~ 2500	80 ~ 120	0.5 ~ 5.0
TCGT 16T308	CAP	CA	0.15 ~ 0.50	0.15 ~ 0.30	200 ~ 2500	80 ~ 120	0.5 ~ 5.0
TCGT 16T312	CAP	CA	0.20 ~ 0.80	0.20 ~ 0.40	200 ~ 2500	80 ~ 120	0.8 ~ 5.0
TCGT 16T316	CAP	CA					
VCGT 110302	CAP	CA	0.05 ~ 0.15	0.05 ~ 0.10	200 ~ 2500	80 ~ 120	0.3 ~ 2.0
VCGT 110304	CAP	CA	0.10 ~ 0.30	0.10 ~ 0.20	200 ~ 2500	80 ~ 120	0.5 ~ 2.0
VCGT 110308	CAP	CA	0.15 ~ 0.50	0.15 ~ 0.30	200 ~ 2500	80 ~ 120	0.5 ~ 2.0
VCGT 130302	CAP	CA	0.05 ~ 0.15	0.05 ~ 0.10	200 ~ 2500	80 ~ 120	0.3 ~ 2.0
VCGT 130304	CAP	CA	0.10 ~ 0.30	0.10 ~ 0.20	200 ~ 2500	80 ~ 120	0.5 ~ 2.0
VCGT 160402	CAP	CA	0.05 ~ 0.15	0.05 ~ 0.10	200 ~ 2500	80 ~ 120	0.3 ~ 3.0
VCGT 160404	CAP	CA	0.10 ~ 0.30	0.10 ~ 0.20	200 ~ 2500	80 ~ 120	0.5 ~ 3.0
VCGT 160408	CAP	CA	0.15 ~ 0.50	0.15 ~ 0.30	200 ~ 2500	80 ~ 120	0.5 ~ 3.0
VCGT 160412	CAP	CA	0.20 ~ 0.80	0.20 ~ 0.40	200 ~ 2500	80 ~ 120	0.5 ~ 3.0
VCGT 220525	CAP	CA			200 ~ 2500		
VCGT 220530	CAP	CA			200 ~ 2500		

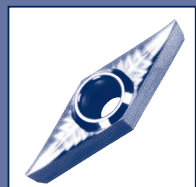
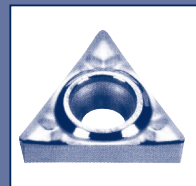
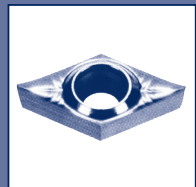

• These are indications only

COMBIDEX[®] BV

Nieuwe Waterwegstraat 5
3115 HE Schiedam
Netherlands

